

# 2MBI75N-060

IGBT Module

## 600V / 75A 2 in one-package

### ■ Features

- High speed switching
- Voltage drive
- Low inductance module structure

### ■ Applications

- Inverter for Motor drive
- AC and DC Servo drive amplifier
- Uninterruptible power supply
- Industrial machines, such as Welding machines



### ■ Maximum ratings and characteristics

#### ● Absolute maximum ratings (at Tc=25°C unless otherwise specified)

Item	Symbol	Rating	Unit
Collector-Emitter voltage	V <sub>CEs</sub>	600	V
Gate-Emitter voltage	V <sub>GES</sub>	±20	V
Collector current	Continuous	I <sub>c</sub>	75 A
	1ms	I <sub>c</sub> pulse	150 A
	Continuous	-I <sub>c</sub>	75 A
	1ms	-I <sub>c</sub> pulse	150 A
Max. power dissipation	P <sub>c</sub>	320	W
Operating temperature	T <sub>j</sub>	+150	°C
Storage temperature	T <sub>stg</sub>	-40 to +125	°C
Isolation voltage	V <sub>is</sub>	AC 2500 (1min.)	V
Screw torque	Mounting *1	3.5	N·m
	Terminals *1	3.5	N·m

\*1 : Recommendable value : 2.5 to 3.5 N·m(M5)

#### ■ Equivalent Circuit Schematic

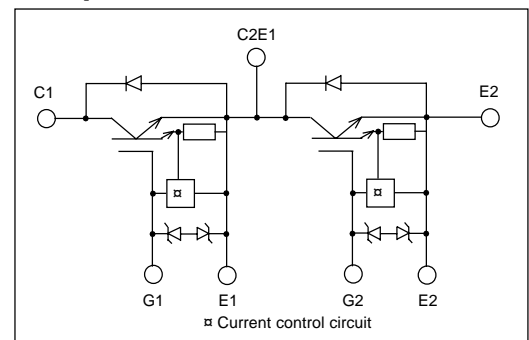

#### ● Electrical characteristics (at Tj=25°C unless otherwise specified)

Item	Symbol	Characteristics			Conditions	Unit
		Min.	Typ.	Max.		
Zero gate voltage collector current	I <sub>CEs</sub>	–	–	1.0	V <sub>GE</sub> =0V, V <sub>CE</sub> =600V	mA
Gate-Emitter leakage current	I <sub>GES</sub>	–	–	15	V <sub>CE</sub> =0V, V <sub>GE</sub> =±20V	μA
Gate-Emitter threshold voltage	V <sub>GE(th)</sub>	4.5	–	7.5	V <sub>CE</sub> =20V, I <sub>c</sub> =75mA	V
Collector-Emitter saturation voltage	V <sub>CE(sat)</sub>	–	–	2.8	V <sub>GE</sub> =15V, I <sub>c</sub> =75A	V
Input capacitance	C <sub>ies</sub>	–	4950	–	V <sub>GE</sub> =0V	pF
Output capacitance	C <sub>oes</sub>	–	1100	–	V <sub>CE</sub> =10V	
Reverse transfer capacitance	C <sub>res</sub>	–	500	–	f=1MHz	
Turn-on time	t <sub>on</sub>	–	0.6	1.2	V <sub>CC</sub> =300V	μs
	t <sub>r</sub>	–	0.2	0.6	I <sub>c</sub> =75A	
Turn-off time	t <sub>off</sub>	–	0.6	1.0	V <sub>GE</sub> =±15V	μs
	t <sub>f</sub>	–	0.2	0.35	R <sub>G</sub> =33 ohm	
Diode forward on voltage	V <sub>F</sub>	–	–	3.0	I <sub>F</sub> =75A, V <sub>GE</sub> =0V	V
Reverse recovery time	t <sub>rr</sub>	–	–	0.3	I <sub>F</sub> =75A	μs

#### ● Thermal resistance characteristics

Item	Symbol	Characteristics			Conditions	Unit
		Min.	Typ.	Max.		
Thermal resistance	R <sub>th(j-c)</sub>	–	–	0.39	IGBT	°C/W
	R <sub>th(j-c)</sub>	–	–	0.9	Diode	°C/W
	R <sub>th(c-f)*2</sub>	–	0.05	–	the base to cooling fin	°C/W

\*2 : This is the value which is defined mounting on the additional cooling fin with thermal compound

■ Characteristics (Representative)

Collector current vs. Collector-Emitter voltage  
T<sub>J</sub>=25°C

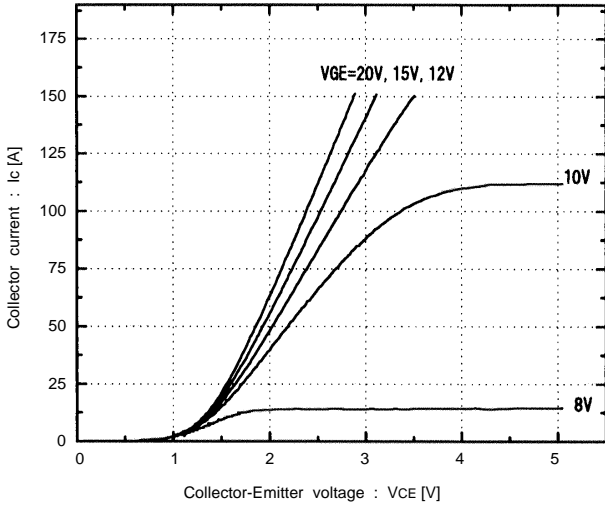

Collector current vs. Collector-Emitter voltage  
T<sub>J</sub>=125°C

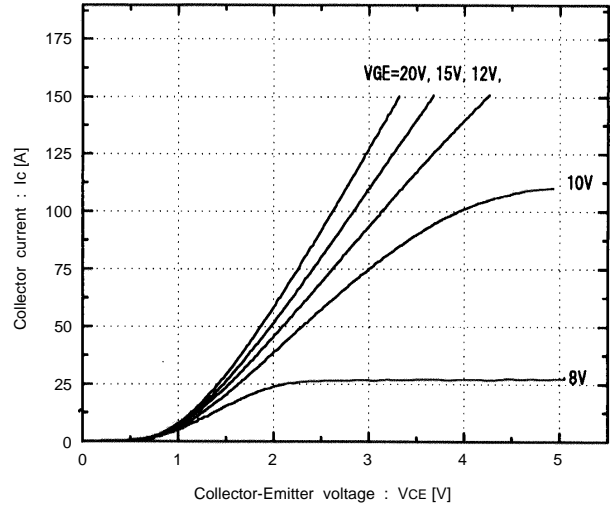

Collector-Emitter vs. Gate-Emitter voltage  
T<sub>J</sub>=25°C

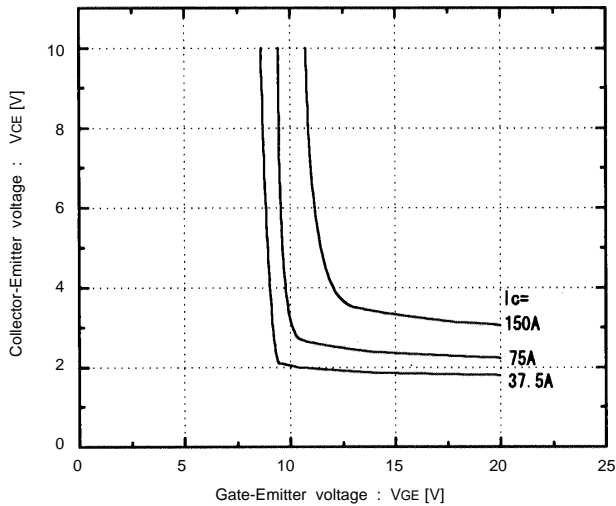

Collector-Emitter vs. Gate-Emitter voltage  
T<sub>J</sub>=125°C

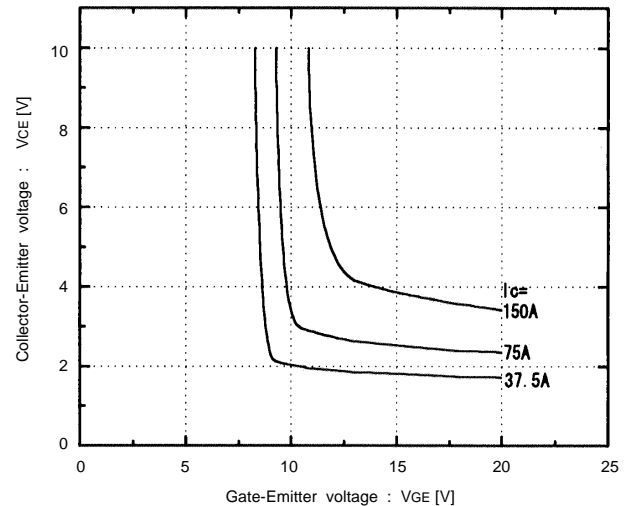

Switching time vs. Collector current  
V<sub>CC</sub>=300V, R<sub>G</sub>=33 ohm, V<sub>GE</sub>=±15V, T<sub>J</sub>=25°C

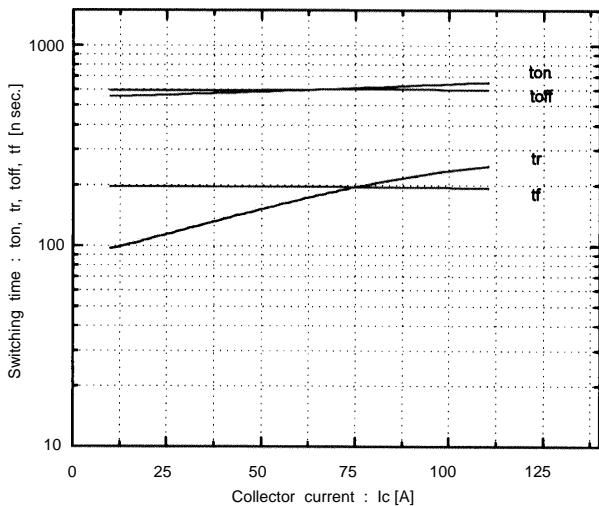

Switching time vs. Collector current  
V<sub>CC</sub>=300V, R<sub>G</sub>=33 ohm, V<sub>GE</sub>=±15V, T<sub>J</sub>=125°C

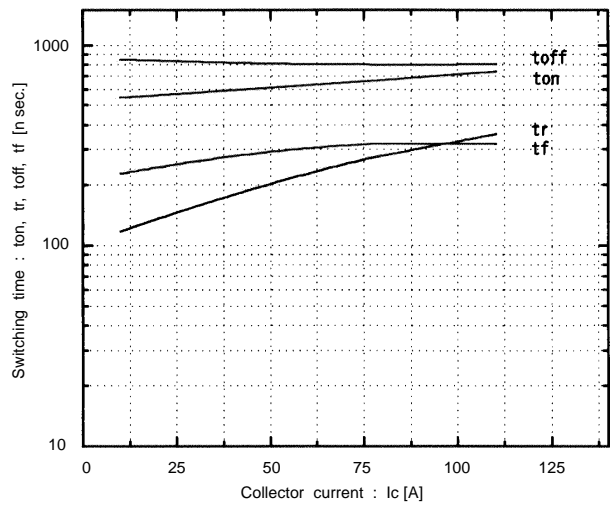

Switching time vs. RG  
Vcc=300V, Ic=75A, VGE=±15V, Tj=25°C

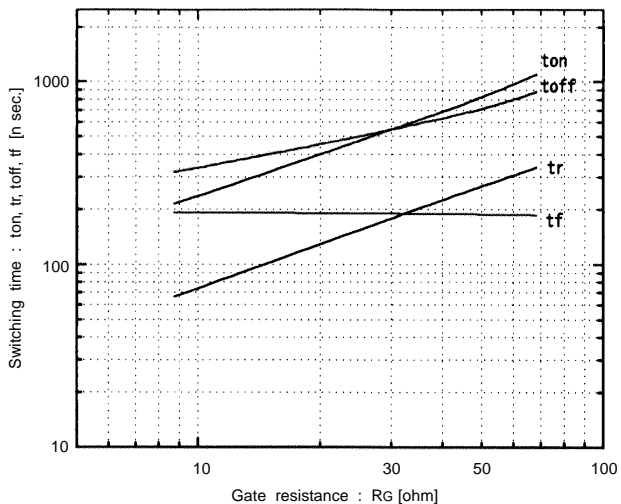

Dynamic input characteristics  
Tj=25°C

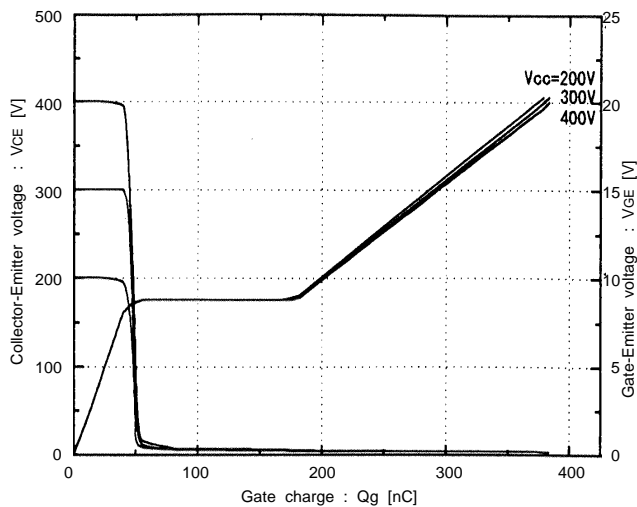

Forward current vs. Forward voltage  
VGE=0V

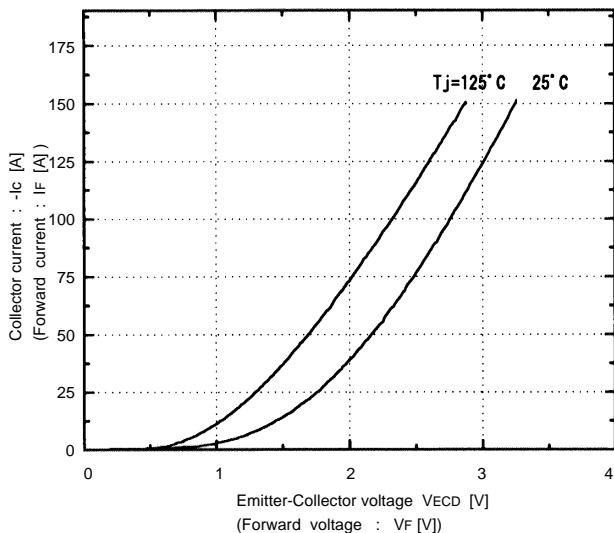

Reverse recovery characteristics  
trr, Irr, vs. IF

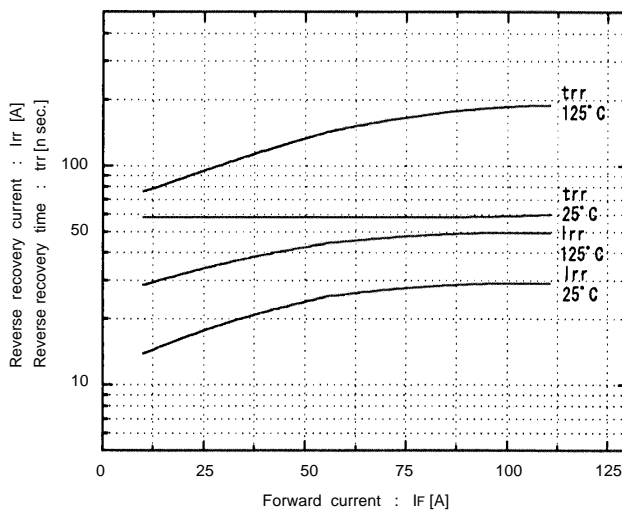

Switching loss vs. Collector current  
Vcc=300V, RG=33 ohm, VGE=±15V

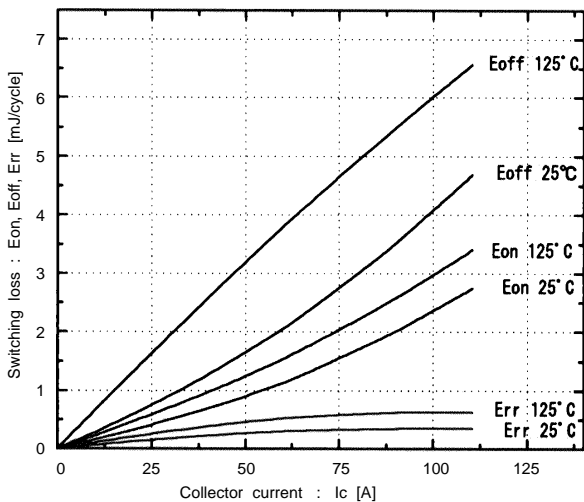

Reversed biased safe operating area  
+VGE=15V, -VGE ≤ 15V, Tj ≤ 125°C, RG ≥ 33 ohm

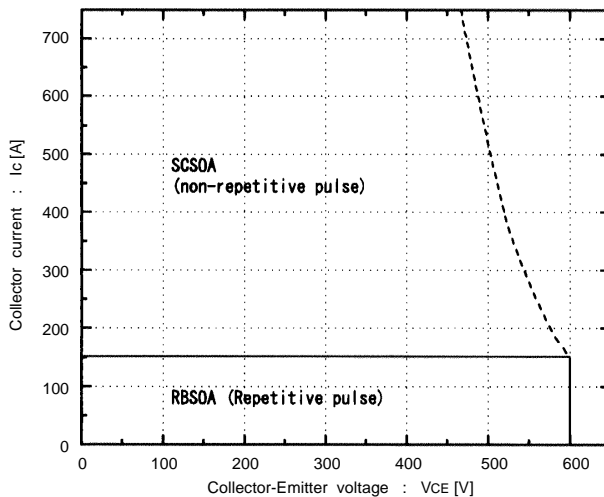

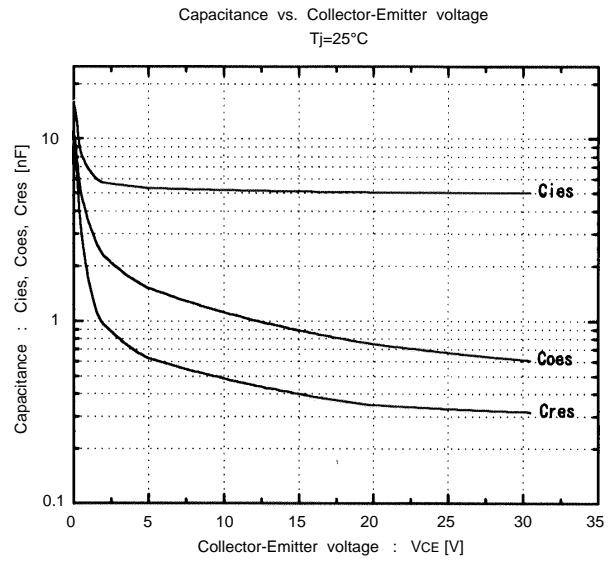
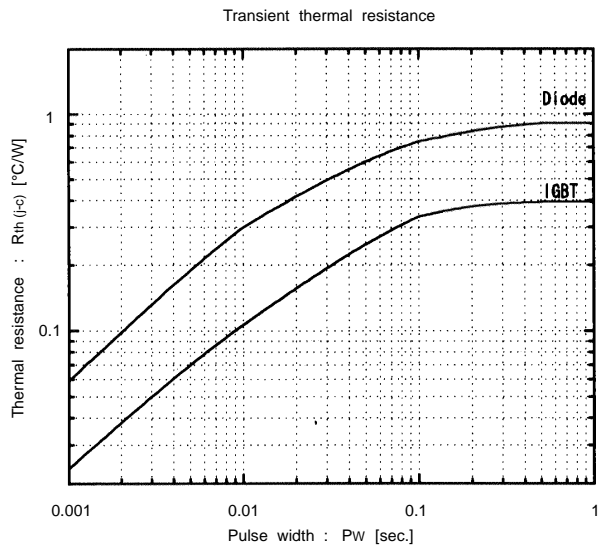

■ Outline Drawings, mm

