

# 6MBP75RA120

## IGBT-IPM R series

1200V / 75A 6 in one-package

### ■ Features

- Temperature protection provided by directly detecting the junction temperature of the IGBTs
- Low power loss and soft switching
- Compatible with existing IPM-N series packages
- High performance and high reliability IGBT with overheating protection
- Higher reliability because of a big decrease in number of parts in built-in control circuit

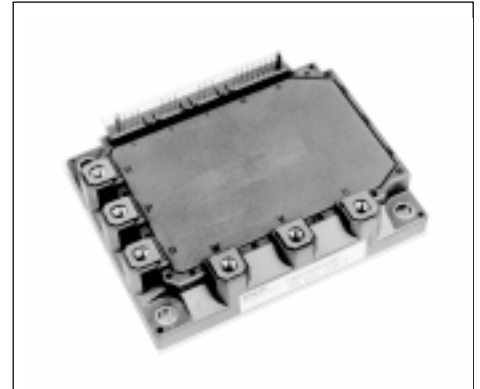

### ■ Maximum ratings and characteristics

- Absolute maximum ratings(at  $T_c=25^\circ\text{C}$  unless otherwise specified)

Item	Symbol	Rating		Unit		
		Min.	Max.			
DC bus voltage	$V_{DC}$	0	900	V		
DC bus voltage (surge)	$V_{DC(surge)}$	0	1000	V		
DC bus voltage (short operating)	$V_{SC}$	200	800	V		
Collector-Emitter voltage	$V_{CES}$	0	1200	V		
INV	Collector current	DC	$I_C$	-	75	A
		1ms	$I_{CP}$	-	150	A
		DC	$-I_C$	-	75	A
	Collector power dissipation	One transistor	$P_C$	-	500	W
Junction temperature	$T_J$	-	150	$^\circ\text{C}$		
Input voltage of power supply for Pre-Driver	$V_{CC}^*1$	0	20	V		
Input signal voltage	$V_{in}^*2$	0	$V_z$	V		
Input signal current	$I_{in}$	-	1	mA		
Alarm signal voltage	$V_{ALM}^*3$	0	$V_{CC}$	V		
Alarm signal current	$I_{ALM}^*4$	-	15	mA		
Storage temperature	$T_{stg}$	-40	125	$^\circ\text{C}$		
Operating case temperature	$T_{op}$	-20	100	$^\circ\text{C}$		
Isolating voltage (Case-Terminal)	$V_{iso}^*5$	-	AC2.5	kV		
Screw torque	Mounting (M5)	-	3.5 <sup>*6</sup>	N·m		
	Terminal (M5)	-	3.5 <sup>*6</sup>	N·m		

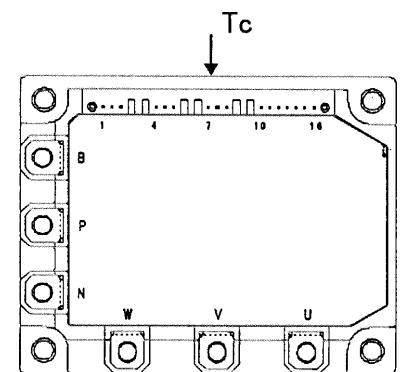

Fig.1 Measurement of case temperature

\*1 Apply  $V_{CC}$  between terminal No. 3 and 1, 6 and 4, 9 and 7, 11 and 10.

\*2 Apply  $V_{in}$  between terminal No. 2 and 1, 5 and 4, 8 and 7, 13,14,15 and 10.

\*3 Apply  $V_{ALM}$  between terminal No. 16 and 10.

\*4 Apply  $I_{ALM}$  to terminal No. 16.

\*5 50Hz/60Hz sine wave 1 minute.

\*6 Recommendable Value : 2.5 to 3.0 N·m

### ● Electrical characteristics of power circuit (at $T_c=T_J=25^\circ\text{C}$ , $V_{CC}=15\text{V}$ )

Item	Symbol	Condition	Min.	Typ.	Max.	Unit	
INV	Collector current at off signal input	$I_{CES}$	$V_{CE}=1200\text{V}$ input terminal open	-	-	1.0	mA
	Collector-Emitter saturation voltage	$V_{CE(sat)}$	$I_C=75\text{A}$	-	-	2.6	V
	Forward voltage of FWD	$V_F$	$-I_C=75\text{A}$	-	-	3.0	V

● Electrical characteristics of control circuit(at Tc=Tj=25°C, Vcc=15V)

Item	Symbol	Condition	Min.	Typ.	Max.	Unit
Power supply current of P-line side Pre-driver(one unit)	I <sub>ccp</sub>	fsw=0 to 15kHz Tc=-20 to 100°C *7	3	-	18	mA
Power supply current of N-line side three Pre-driver	I <sub>ccn</sub>	fsw=0 to 15kHz Tc=-20 to 100°C *7	10	-	65	mA
Input signal threshold voltage (on/off)	V <sub>in(th)</sub>	ON	1.00	1.35	1.70	V
		OFF	1.25	1.60	1.95	V
Input zener voltage	V <sub>Z</sub>	R <sub>in</sub> =20k ohm	-	8.0	-	V
Over heating protection temperature level	T <sub>COH</sub>	VDC=0V, I <sub>c</sub> =0A, Case temperature	110	-	125	°C
Hysteresis	T <sub>CH</sub>		-	20	-	°C
IGBT chips over heating protection temperature level	T <sub>JOH</sub>	surface of IGBT chips	150	-	-	°C
Hysteresis	T <sub>JH</sub>		-	20	-	°C
Collector current protection level	INV	I <sub>oc</sub>	113	-	-	A
Over current protection delay time (Fig.2)	t <sub>DOC</sub>	T <sub>j</sub> =25°C Fig.2	-	10	-	μs
Under voltage protection level	V <sub>UV</sub>		11.0	-	12.5	V
Hysteresis	V <sub>H</sub>		0.2	-	-	V
Alarm signal hold time	t <sub>ALM</sub>		1.5	2	-	ms
SC protection delay time	t <sub>SC</sub>	T <sub>j</sub> =25°C Fig.3	-	-	12	μs
Limiting resistor for alarm	R <sub>ALM</sub>		1425	1500	1575	ohm

\*7 Switching frequency of IGBT

● Dynamic characteristics(at Tc=Tj=125°C, Vcc=15V)

Item	Symbol	Condition	Min.	Typ.	Max.	Unit
Switching time (IGBT)	ton	I <sub>C</sub> =75A, VDC=600V	0.3	-	-	μs
	toff		-	-	3.6	μs
Switching time (FWD)	t <sub>rr</sub>	I <sub>F</sub> =75A, VDC=600V	-	-	0.4	μs

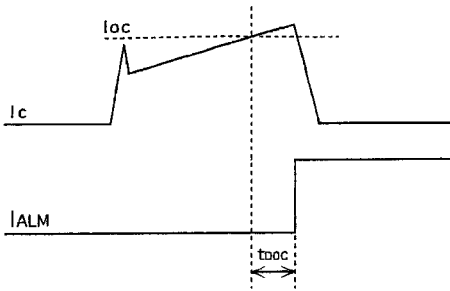

Fig.2 Definition of OC delay time

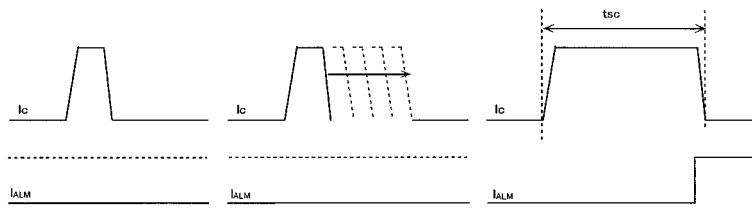

Fig.3 Definition of tsc

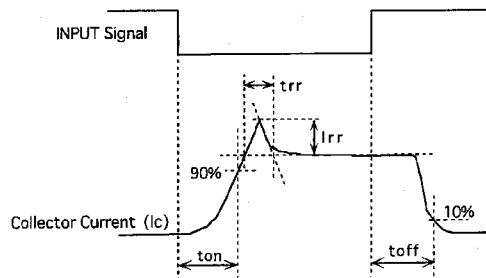

Fig.4 Definition of switching time

● Thermal characteristics(Tc=25°C)

Item	Symbol	Typ.	Max.	Unit		
Junction to Case thermal resistance	INV	IGBT	R <sub>th(j-c)</sub>	-	0.25	°C/W
			FWD	R <sub>th(j-c)</sub>	-	0.73
Case to fin thermal resistance with compound		R <sub>th(c-f)</sub>	0.05	-	°C/W	

● Recommendable value

Item	Symbol	Min.	Typ.	Max.	Unit	
DC bus voltage	V <sub>DC</sub>	200	-	800	V	
Operating power supply voltage range of Pre-driver	V <sub>CC</sub>	13.5	15	16.5	V	
Switching frequency of IPM	fsw	1	-	20	kHz	
Screw torque	Mounting (M5)	-	2.5	-	3.0	N·m
	Terminal (M5)	-	2.5	-	3.0	N·m

Block diagram

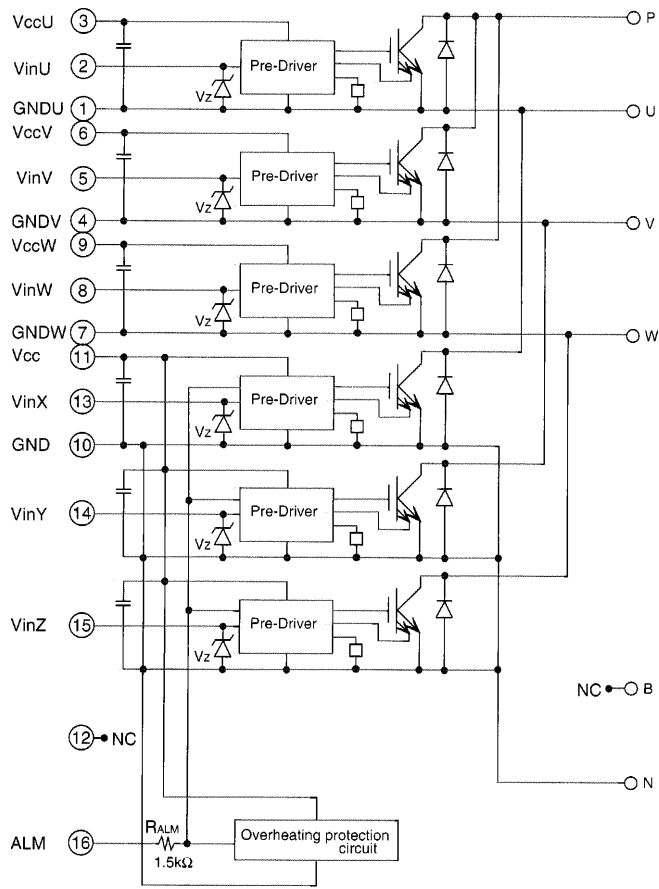

- Pre-drivers include following functions
- a) Amplifier for driver
  - b) Short circuit protection
  - c) Undervoltage lockout circuit
  - d) Over current protection
  - e) IGBT chip over heating protection

Outline drawings, mm

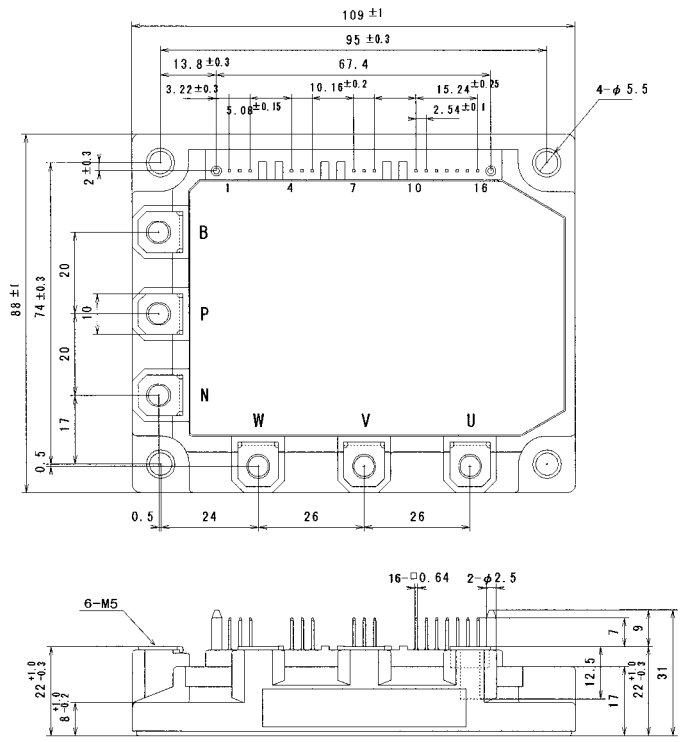

Characteristics (Representative)

Control Circuit

Power supply current vs. Switching frequency  
T<sub>j</sub>=100°C

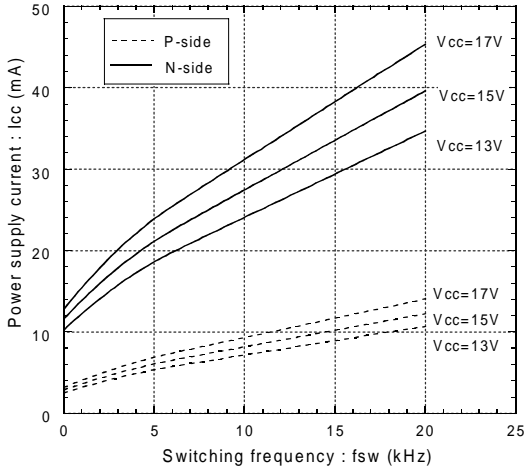

Input signal threshold voltage vs. Power supply voltage  
T<sub>j</sub>=25°C (solid line), T<sub>j</sub>=125°C (dashed line)

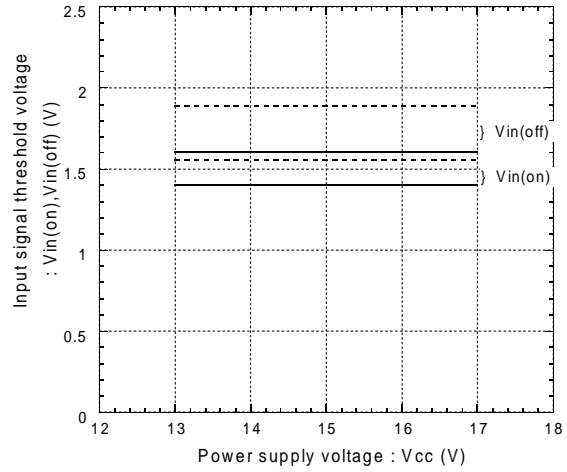

Under voltage vs. Junction temperature

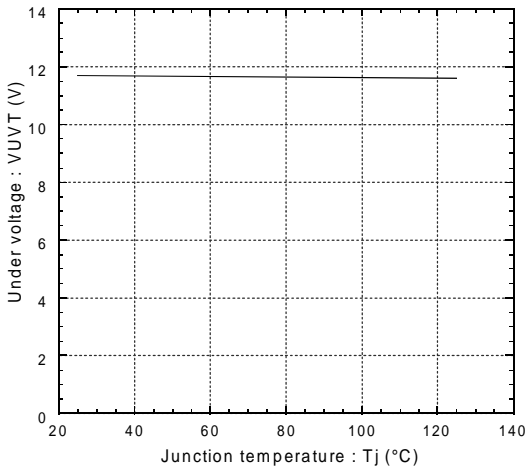

Under voltage hysteresis vs. Junction temperature

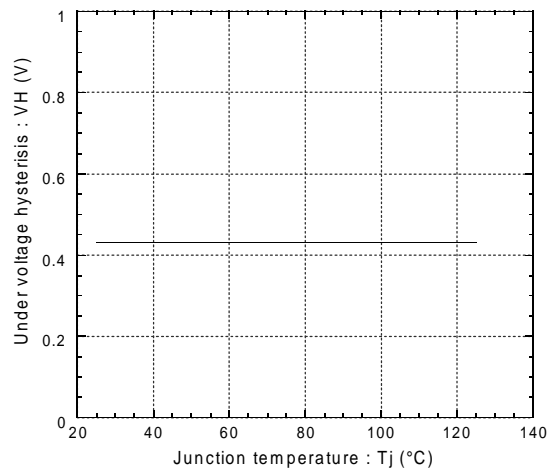

Alarm hold time vs. Power supply voltage

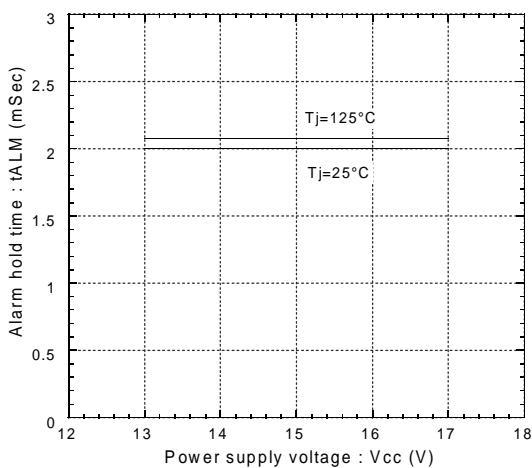

Over heating characteristics  
T<sub>cOH</sub>, T<sub>jOH</sub>, T<sub>cH</sub>, T<sub>jH</sub> vs. V<sub>cc</sub>

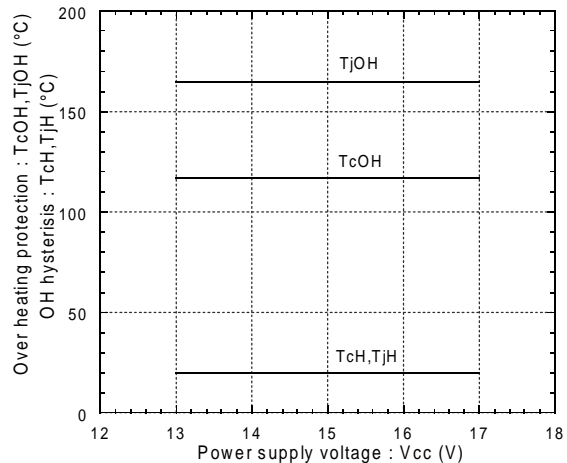

● Inverter

Collector current vs. Collector-Emittter voltage  
T<sub>j</sub>=25°C

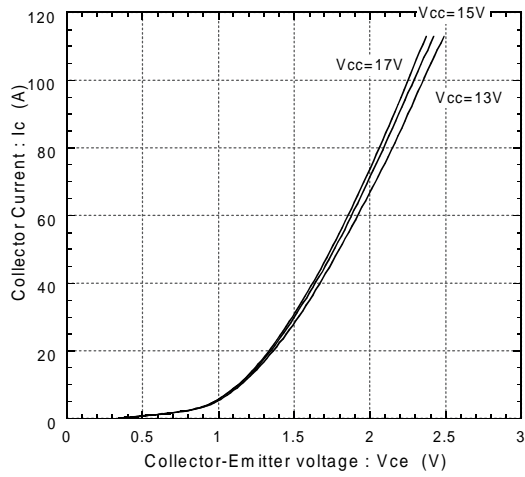

Collector current vs. Collector-Emittter voltage  
T<sub>j</sub>=125°C

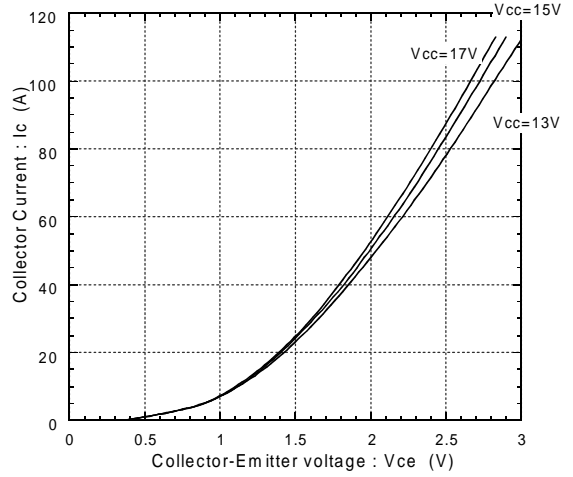

Switching time vs. Collector current  
E<sub>dc</sub>=600V, V<sub>cc</sub>=15V, T<sub>j</sub>=25°C

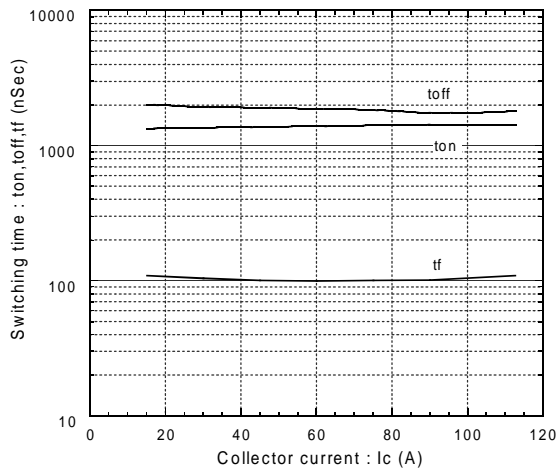

Switching time vs. Collector current  
E<sub>dc</sub>=600V, V<sub>cc</sub>=15V, T<sub>j</sub>=125°C

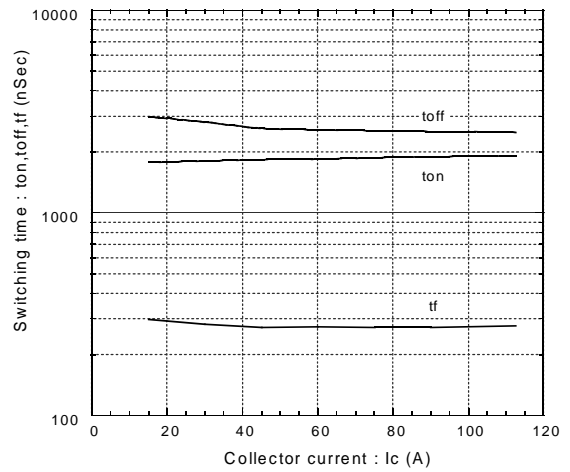

Forward current vs. Forward voltage

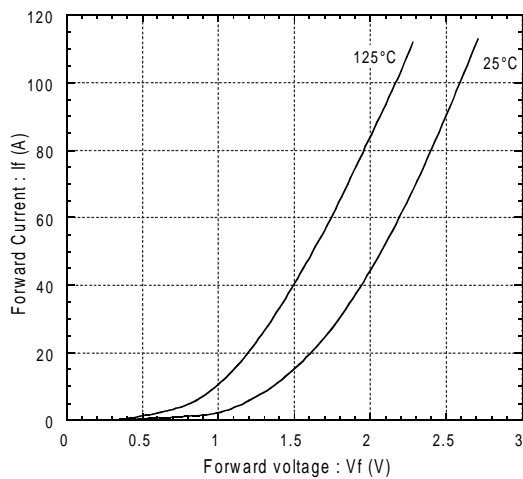

Reverse recovery characteristics  
trr, lrr vs. IF

