

SPECIFICATION

Device Name : IGBT MODULE

Type Name : 2MBI100U4A-120

Spec. No. : MS5F 6061

This material and the information herein is the property of Fuji Electric Device Technology Co.,Ltd. They shall be neither reproduced, copied, lent, or disclosed in any way whatsoever for the use of any third party nor used for the manufacturing purposes without the express written consent of Fuji Electric Device Technology Co.,Ltd.

| | DATE | NAME | APPROVED | Fuji Electric Device Technology Co.,Ltd. | | |
|---------|---------------|-------------|----------|---|-----------------|-----|
| DRAWN | Mar.- 09 -'05 | S.Miyashita | Y.Seki | DWG.NO. | MS5F6061 | 1 / |
| CHECKED | Mar.- 09 -'05 | T.Miyasaka | | | | 13 |
| CHECKED | - - | K.Yamada | | | | |

Revised Records

| Date | Classi- fication | Ind. | Content | Applied date | Drawn | Checked | Checked | Approved |
|-------------|---------------------|------|---------|-----------------|-------|------------|----------|----------|
| Mar.-09 '05 | Enactment | — | ————— | Issued date | — | T.Miyasaka | K.Yamada | Y.Seki |
| | | | | | | | | |
| | | | | | | | | |
| | | | | | | | | |
| | | | | | | | | |
| | | | | | | | | |
| | | | | | | | | |
| | | | | | | | | |
| | | | | | | | | |
| | | | | | | | | |
| | | | | | | | | |
| | | | | | | | | |
| | | | | | | | | |
| | | | | | | | | |
| | | | | | | | | |
| | | | | | | | | |
| | | | | | | | | |
| | | | | | | | | |
| | | | | | | | | |
| | | | | | | | | |
| | | | | | | | | |
| | | | | | | | | |

This material and the information herein is the property of Fuji Electric Device Technology Co., Ltd. They shall be neither reproduced, copied, lent, or disclosed in any way whatsoever for the use of any third party nor used for the manufacturing purposes without the express written consent of Fuji Electric Device Technology Co., Ltd.

2MBI100U4A-120

1. Outline Drawing (Unit : mm)

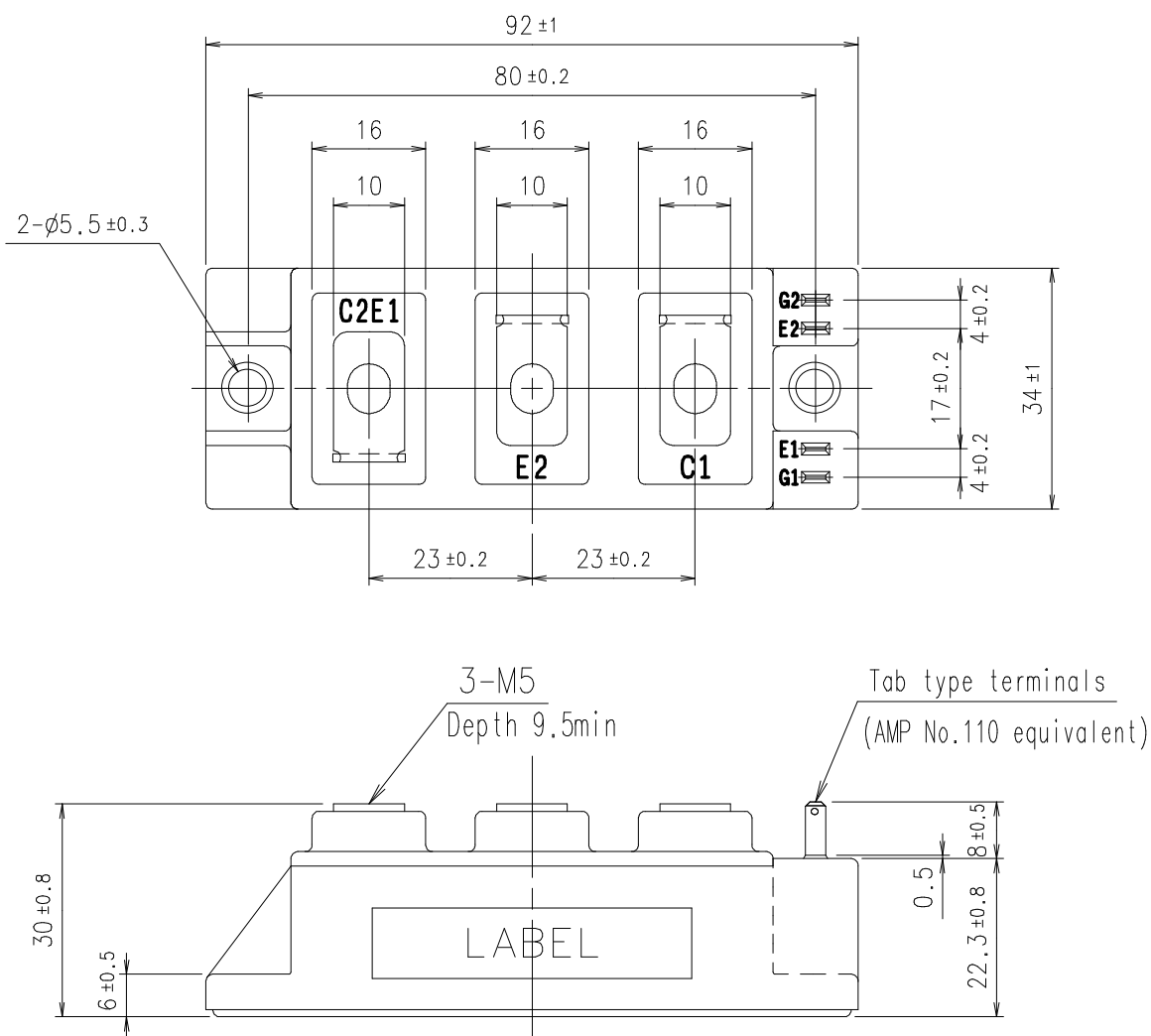

This material and the information herein is the property of Fuji Electric Device Technology Co.,Ltd. They shall be neither reproduced, copied, lent, or disclosed in any way whatsoever for the use of any third party nor used for the manufacturing purposes without the express written consent of Fuji Electric Device Technology Co.,Ltd.

2. Equivalent circuit

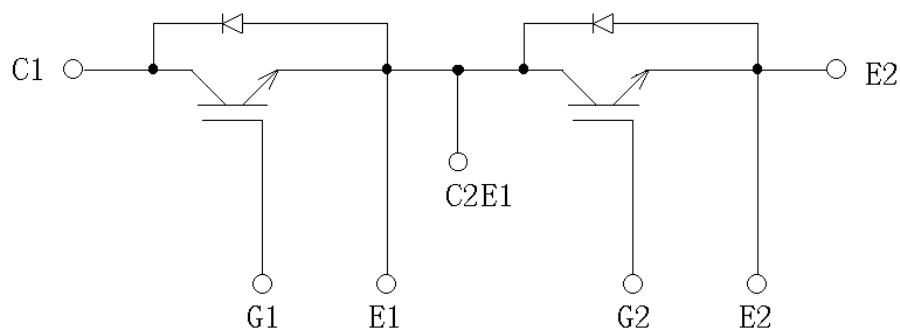

3. Absolute Maximum Ratings (at Tc= 25°C unless otherwise specified)

| Items | | Symbols | Conditions | Maximum Ratings | Units |
|-----------------------------|---------------------------------------|------------|------------|-----------------|-------|
| Collector-Emitter voltage | | VCES | | 1200 | V |
| Gate-Emitter voltage | | VGES | | ±20 | V |
| Collector current | Ic | Continuous | Tc=25°C | 150 | A |
| | | | Tc=80°C | 100 | |
| | Icp | 1ms | Tc=25°C | 300 | |
| | | | Tc=80°C | 200 | |
| | -Ic | | | 100 | |
| -Ic pulse | 1ms | | 200 | | |
| Collector Power Dissipation | | Pc | 1 device | 540 | W |
| Junction temperature | | Tj | | +150 | °C |
| Storage temperature | | Tstg | | -40 to +125 | |
| Isolation voltage | between terminal and copper base (*1) | Viso | AC : 1min. | 2500 | VAC |
| Screw Torque | Mounting (*2) | | | 3.5 | N m |
| | Terminals (*2) | | | | |

(*1) All terminals should be connected together when isolation test will be done.

(*2) Recommendable Value : 2.5 to 3.5 Nm (M5)

4. Electrical characteristics (at Tj= 25°C unless otherwise specified)

| Items | Symbols | Conditions | Characteristics | | | Units | |
|--------------------------------------|---------------------|-------------------------|-----------------|------|------|-------|---|
| | | | min. | typ. | max. | | |
| Zero gate voltage collector current | ICES | VCE=1200V VGE=0V | - | - | 1.0 | mA | |
| Gate-Emitter leakage current | IGES | VCE=0V VGE=±20V | - | - | 200 | nA | |
| Gate-Emitter threshold voltage | VGE(th) | VCE=20V Ic=100mA | 4.5 | 6.5 | 8.5 | V | |
| Collector-Emitter saturation voltage | VCE(sat) (terminal) | Ic=100A VGE=15V | Tj=25°C | - | 2.05 | 2.20 | V |
| | | | Tj=125°C | - | 2.25 | - | |
| | VCE(sat) (chip) | | Tj=25°C | - | 1.90 | 2.05 | |
| | | | Tj=125°C | - | 2.10 | - | |
| Input capacitance | Cies | VCE=10V, VGE=0V, f=1MHz | - | 11 | - | nF | |
| Turn-on time | ton | Vcc=600V | - | 0.32 | 1.20 | us | |
| | tr | Ic=100A | - | 0.10 | 0.60 | | |
| | tr(i) | VGE=±15V | - | 0.03 | - | | |
| Turn-off time | toff | RG=5.6Ω | - | 0.41 | 1.00 | us | |
| | tf | | - | 0.07 | 0.30 | | |
| Forward on voltage | VF (terminal) | IF=100A VGE=0V | Tj=25°C | - | 1.80 | 1.95 | V |
| | | | Tj=125°C | - | 1.90 | - | |
| | VF (chip) | | Tj=25°C | - | 1.65 | 1.80 | |
| | | | Tj=125°C | - | 1.75 | - | |
| Reverse recovery time | trr | IF=100A | - | - | 0.35 | us | |
| Lead resistance, terminal-chip (*3) | R lead | | - | 1.39 | - | mΩ | |

(*3) Biggest internal terminal resistance among arm.

This material and the information herein is the property of Fuji Electric Device Technology Co.,Ltd. They shall be neither reproduced, copied, lent, or disclosed in any way whatsoever for the use of any third party nor used for the manufacturing purposes without the express written consent of Fuji Electric Device Technology Co.,Ltd.

5. Thermal resistance characteristics

| Items | Symbols | Conditions | Characteristics | | | Units |
|--|----------|-----------------------|-----------------|------|------|-------|
| | | | min. | typ. | max. | |
| Thermal resistance(1 device) | Rth(j-c) | IGBT | - | - | 0.23 | °C/W |
| | | FWD | - | - | 0.40 | |
| Contact Thermal resistance (1 device) (*4) | Rth(c-f) | with Thermal Compound | - | 0.05 | - | |

(*4) This is the value which is defined mounting on the additional cooling fin with thermal compound.

6. Indication on module

Logo of production

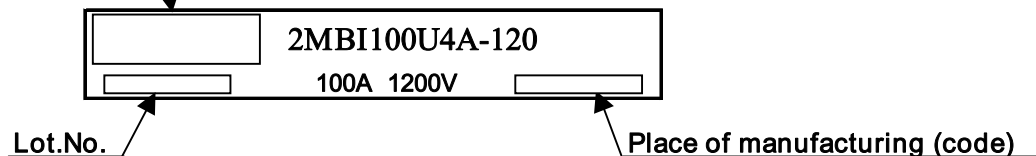

7. Applicable category

This specification is applied to IGBT-Module named 2MBI100U4A-120.

8. Storage and transportation notes

- The module should be stored at a standard temperature of 5 to 35°C and humidity of 45 to 75% .
- Store modules in a place with few temperature changes in order to avoid condensation on the module surface.
- Avoid exposure to corrosive gases and dust.
- Avoid excessive external force on the module.
- Store modules with unprocessed terminals.
- Do not drop or otherwise shock the modules when transporting.

9. Definitions of switching time

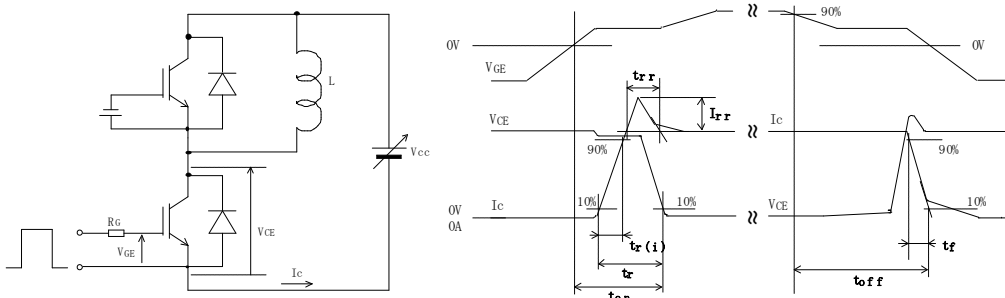

10. Packing and Labeling

Display on the packing box

- Logo of production
- Type name
- Lot No
- Products quantity in a packing box

11. Reliability test results

Reliability Test Items

| Test categories | Test items | Test methods and conditions | Reference norms EIAJ ED-4701 (Aug.-2001 edition) | Number of sample | Acceptance number |
|-------------------|---------------------------------|--|--|------------------|-------------------|
| Mechanical Tests | 1 Terminal Strength (Pull test) | Pull force : 40N Test time : 10±1 sec. | Test Method 401 Method I | 5 | (0 : 1) |
| | 2 Mounting Strength | Screw torque : 2.5 ~ 3.5 N·m (M5) Test time : 10±1 sec. | Test Method 402 method II | 5 | (0 : 1) |
| | 3 Vibration | Range of frequency : 10 ~ 500Hz Sweeping time : 15 min. Acceleration : 100m/s ² Sweeping direction : Each X,Y,Z axis Test time : 6 hr. (2hr./direction) | Test Method 403 Reference 1 Condition code B | 5 | (0 : 1) |
| | 4 Shock | Maximum acceleration : 5000m/s ² Pulse width : 1.0msec. Direction : Each X,Y,Z axis Test time : 3 times/direction | Test Method 404 Condition code B | 5 | (0 : 1) |
| Environment Tests | 1 High Temperature Storage | Storage temp. : 125±5 °C Test duration : 1000hr. | Test Method 201 | 5 | (0 : 1) |
| | 2 Low Temperature Storage | Storage temp. : -40±5 °C Test duration : 1000hr. | Test Method 202 | 5 | (0 : 1) |
| | 3 Temperature Humidity Storage | Storage temp. : 85±2 °C Relative humidity : 85±5% Test duration : 1000hr. | Test Method 103 Test code C | 5 | (0 : 1) |
| | 4 Unsaturated Pressurized Vapor | Test temp. : 120±2 °C Test humidity : 85±5% Test duration : 96hr. | Test Method 103 Test code E | 5 | (0 : 1) |
| | 5 Temperature Cycle | Test temp. : ┌ Low temp. -40±5 °C ├ High temp. 125 ±5 °C └ RT 5 ~ 35 °C Dwell time : High ~ RT ~ Low ~ RT 1hr. 0.5hr. 1hr. 0.5hr. Number of cycles : 100 cycles | Test Method 105 | 5 | (0 : 1) |
| | 6 Thermal Shock | Test temp. : ┌ High temp. 100 ⁺⁰ °C └ Low temp. 0 ⁻⁰ °C Used liquid : Water with ice and boiling water Dipping time : 5 min. par each temp. Transfer time : 10 sec. Number of cycles : 10 cycles | Test Method 307 method I Condition code A | 5 | (0 : 1) |

This material and the information herein is the property of Fuji Electric Device Technology Co.,Ltd. They shall be neither reproduced, copied, lent, or disclosed in any way whatsoever for the use of any third party nor used for the manufacturing purposes without the express written consent of Fuji Electric Device Technology Co.,Ltd.

Reliability Test Items

| Test categories | Test items | Test methods and conditions | Reference norms EIAJ ED-4701 (Aug.-2001 edition) | Number of sample | Acceptance number |
|-----------------|--|---|--|------------------|-------------------|
| Endurance Tests | 1 High temperature Reverse Bias | Test temp. : $T_a = 125 \pm 5 \text{ }^\circ\text{C}$ ($T_j \leq 150 \text{ }^\circ\text{C}$) Bias Voltage : $V_C = 0.8 \times V_{CES}$ Bias Method : Applied DC voltage to C-E $V_{GE} = 0V$ Test duration : 1000hr. | Test Method 101 | 5 | (0 : 1) |
| | 2 High temperature Bias (for gate) | Test temp. : $T_a = 125 \pm 5 \text{ }^\circ\text{C}$ ($T_j \leq 150 \text{ }^\circ\text{C}$) Bias Voltage : $V_C = V_{GE} = +20V$ or $-20V$ Bias Method : Applied DC voltage to G-E $V_{CE} = 0V$ Test duration : 1000hr. | Test Method 101 | 5 | (0 : 1) |
| | 3 Temperature Humidity Bias | Test temp. : $85 \pm 2 \text{ }^\circ\text{C}$ Relative humidity : $85 \pm 5\%$ Bias Voltage : $V_C = 0.8 \times V_{CES}$ Bias Method : Applied DC voltage to C-E $V_{GE} = 0V$ Test duration : 1000hr. | Test Method 102 Condition code C | 5 | (0 : 1) |
| | 4 Intermittent Operating Life (Power cycle) (for IGBT) | ON time : 2 sec. OFF time : 18 sec. Test temp. : $\Delta T_j = 100 \pm 5 \text{ deg}$ $T_j \leq 150 \text{ }^\circ\text{C}$, $T_a = 25 \pm 5 \text{ }^\circ\text{C}$ Number of cycles : 15000 cycles | Test Method 106 | 5 | (0 : 1) |

Failure Criteria

| Item | Characteristic | Symbol | Failure criteria | | Unit | Note | |
|---------------------------|---|----------|-------------------|-------------|---------|------|--|
| | | | Lower limit | Upper limit | | | |
| Electrical characteristic | Leakage current | ICES | - | USL×2 | mA | | |
| | | ±IGES | - | USL×2 | μA | | |
| | Gate threshold voltage | VGE(th) | LSL×0.8 | USL×1.2 | mA | | |
| | Saturation voltage | VCE(sat) | - | USL×1.2 | V | | |
| | Forward voltage | VF | - | USL×1.2 | V | | |
| | Thermal resistance | IGBT | Δ VGE or Δ VCE | - | USL×1.2 | mV | |
| | | FWD | Δ VF | - | USL×1.2 | mV | |
| | Isolation voltage | Viso | Broken insulation | | - | | |
| Visual inspection | Visual inspection Peeling Plating and the others | - | The visual sample | | - | | |

LSL : Lower specified limit.
USL : Upper specified limit.

Note Each parameter measurement read-outs shall be made after stabilizing the components at room ambient for 2 hours minimum, 24 hours maximum after removal from the tests. And in case of the wetting tests, for example, moisture resistance tests, each component shall be made wipe or dry completely before the measurement.

This material and the information herein is the property of Fuji Electric Device Technology Co.,Ltd. They shall be neither reproduced, copied, lent, or disclosed in any way whatsoever for the use of any third party nor used for the manufacturing purposes without the express written consent of Fuji Electric Device Technology Co.,Ltd.

Reliability Test Results

| Test categories | Test items | Reference norms EIAJ ED-4701 (Aug.-2001 edition) | Number of test sample | Number of failure sample |
|-------------------|---|--|-----------------------|--------------------------|
| Mechanical Tests | 1 Terminal Strength (Pull test) | Test Method 401 Method I | 5 | 0 |
| | 2 Mounting Strength | Test Method 402 method II | 5 | 0 |
| | 3 Vibration | Test Method 403 Condition code B | 5 | 0 |
| | 4 Shock | Test Method 404 Condition code B | 5 | 0 |
| Environment Tests | 1 High Temperature Storage | Test Method 201 | 5 | 0 |
| | 2 Low Temperature Storage | Test Method 202 | 5 | 0 |
| | 3 Temperature Humidity Storage | Test Method 103 Test code C | 5 | * |
| | 4 Unsaturated Pressurized Vapor | Test Method 103 Test code E | 5 | 0 |
| | 5 Temperature Cycle | Test Method 105 | 5 | 0 |
| | 6 Thermal Shock | Test Method 307 method I Condition code A | 5 | 0 |
| Endurance Tests | 1 High temperature Reverse Bias | Test Method 101 | 5 | * |
| | 2 High temperature Bias (for gate) | Test Method 101 | 5 | 0 |
| | 3 Temperature Humidity Bias | Test Method 102 Condition code C | 5 | * |
| | 4 Intermitted Operating Life (Power cycling) (for IGBT) | Test Method 106 | 5 | 0 |

* under confirmation

This material and the information herein is the property of Fuji Electric Device Technology Co.,Ltd. They shall be neither reproduced, copied, lent, or disclosed in any way whatsoever for the use of any third party nor used for the manufacturing purposes without the express written consent of Fuji Electric Device Technology Co.,Ltd.

This material and the information herein is the property of Fuji Electric Device Technology Co.,Ltd. They shall be neither reproduced, copied, lent, or disclosed in any way whatsoever for the use of any third party nor used for the manufacturing purposes without the express written consent of Fuji Electric Device Technology Co.,Ltd.

Collector current vs. Collector-Emitter voltage (typ.)
Tj=25°C / chip

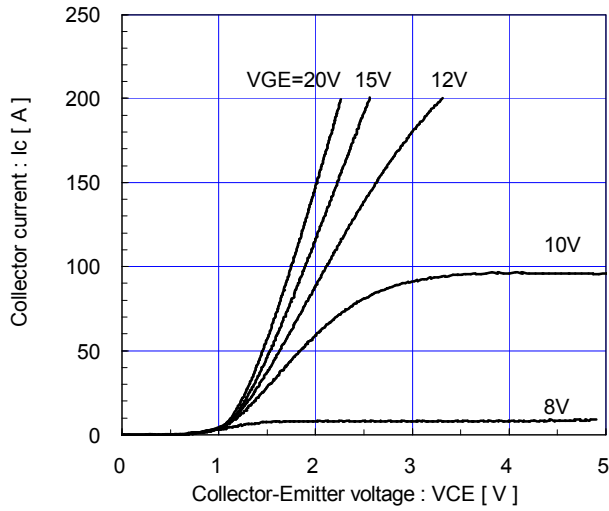

Collector current vs. Collector-Emitter voltage (typ.)
Tj=125°C / chip

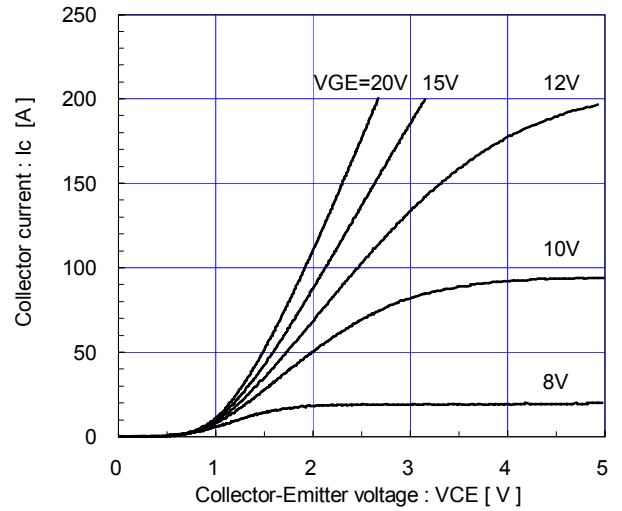

Collector current vs. Collector-Emitter voltage (typ.)
VGE=15V / chip

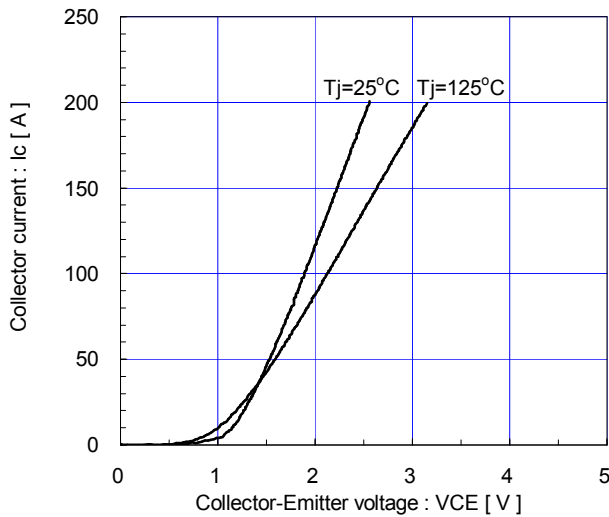

Collector-Emitter voltage vs. Gate-Emitter voltage (typ.)
Tj=25°C / chip

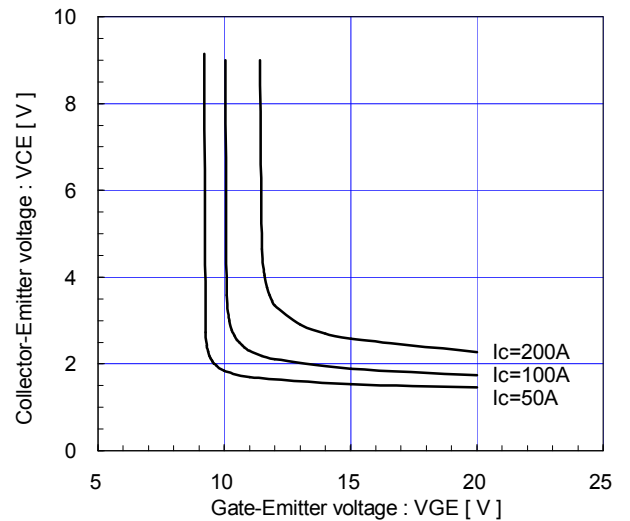

Capacitance vs. Collector-Emitter voltage (typ.)
VGE=0V, f=1MHz, Tj=25°C

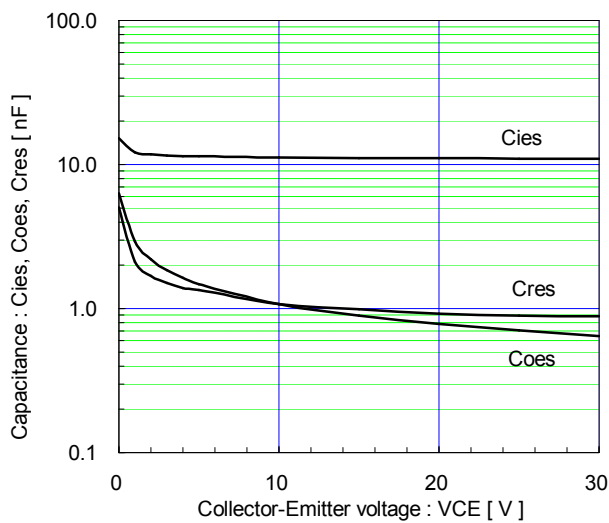

Dynamic Gate charge (typ.)
Vcc=600V, Ic=100A, Tj=25°C

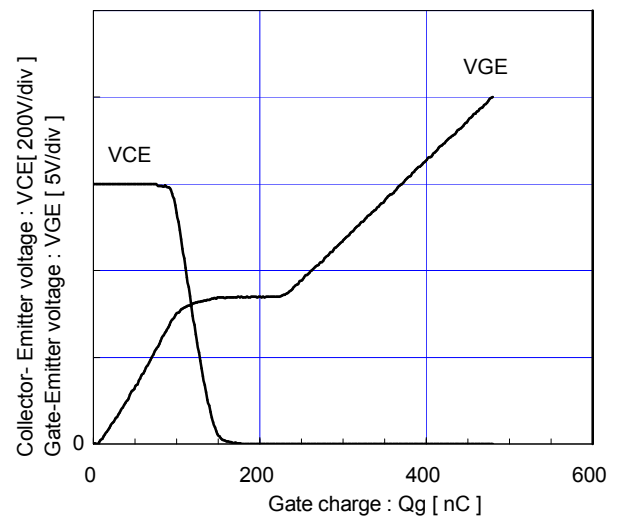

This material and the information herein is the property of Fuji Electric Device Technology Co., Ltd. They shall be neither reproduced, copied, lent, or disclosed in any way whatsoever for the use of any third party nor used for the manufacturing purposes without the express written consent of Fuji Electric Device Technology Co., Ltd.

Switching time vs. Collector current (typ.)
 $V_{CC}=600V, V_{GE}=\pm 15V, R_G=5.6\Omega, T_J=25^\circ C$

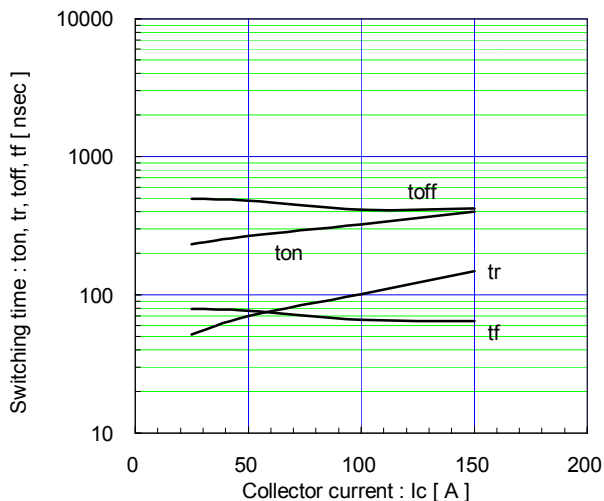

Switching time vs. Collector current (typ.)
 $V_{CC}=600V, V_{GE}=\pm 15V, R_G=5.6\Omega, T_J=125^\circ C$

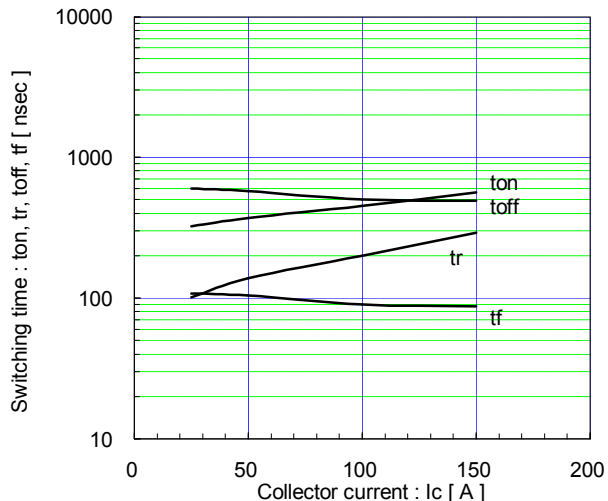

Switching time vs. Gate resistance (typ.)
 $V_{CC}=600V, I_C=100A, V_{GE}=\pm 15V, T_J=25^\circ C$

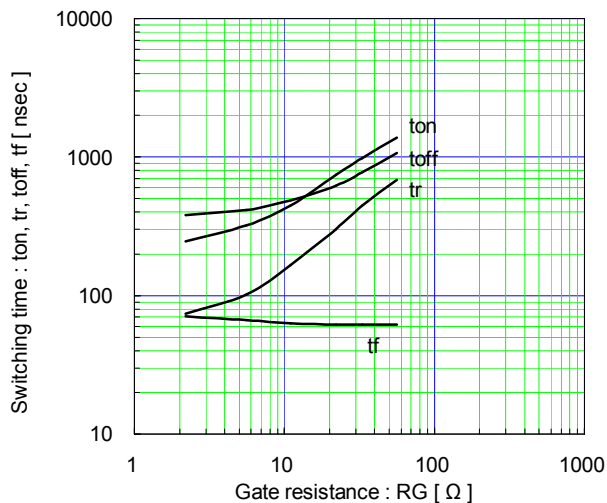

Switching loss vs. Collector current (typ.)
 $V_{CC}=600V, V_{GE}=\pm 15V, R_G=5.6\Omega$

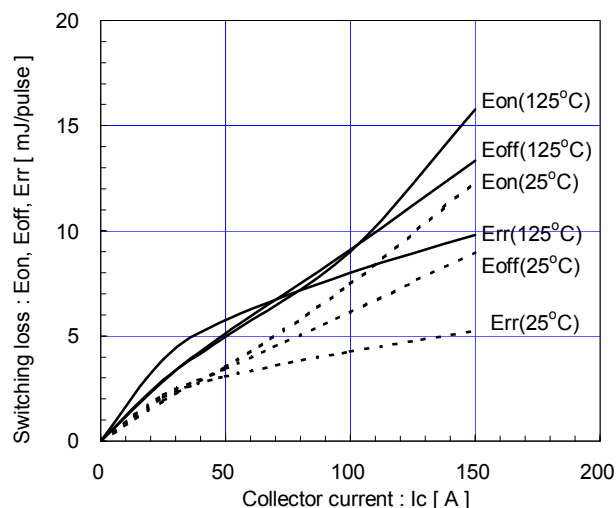

Switching loss vs. Gate resistance (typ.)
 $V_{CC}=600V, I_C=100A, V_{GE}=\pm 15V, T_J=125^\circ C$

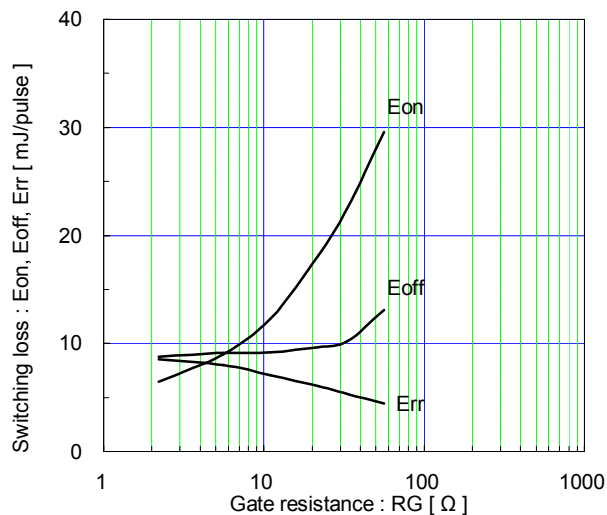

Reverse bias safe operating area (max.)
 $+V_{GE}=15V, -V_{GE} \le 15V, R_G \ge 5.6\Omega, T_J \le 125^\circ C$

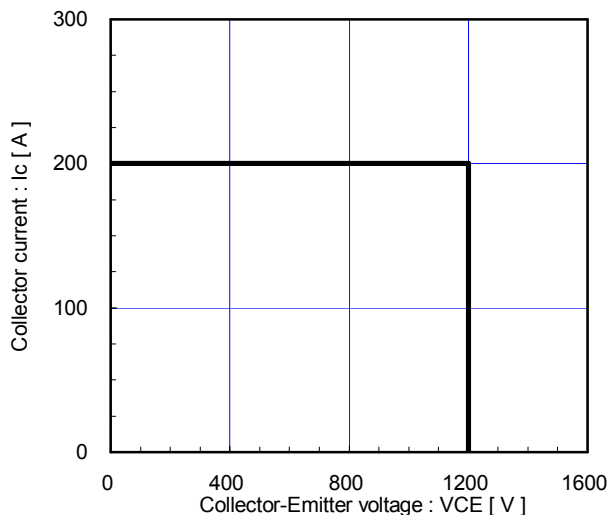

This material and the information herein is the property of Fuji Electric Device Technology Co., Ltd. They shall be neither reproduced, copied, lent, or disclosed in any way whatsoever for the use of any third party nor used for the manufacturing purposes without the express written consent of Fuji Electric Device Technology Co., Ltd.

Forward current vs. Forward on voltage (typ.)
chip

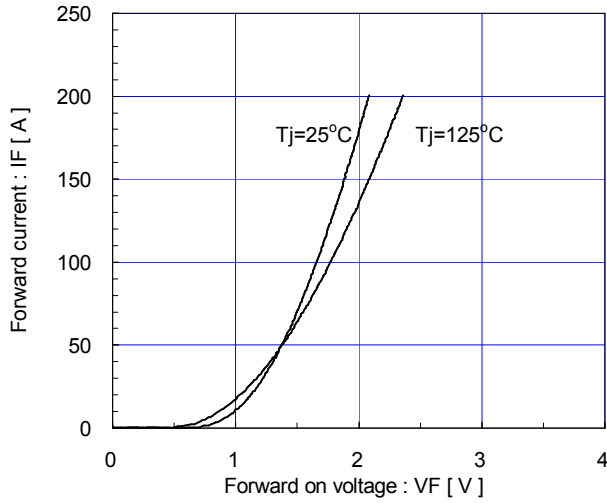

Reverse recovery characteristics (typ.)
Vcc=600V, VGE=±15V, RG=5.6Ω

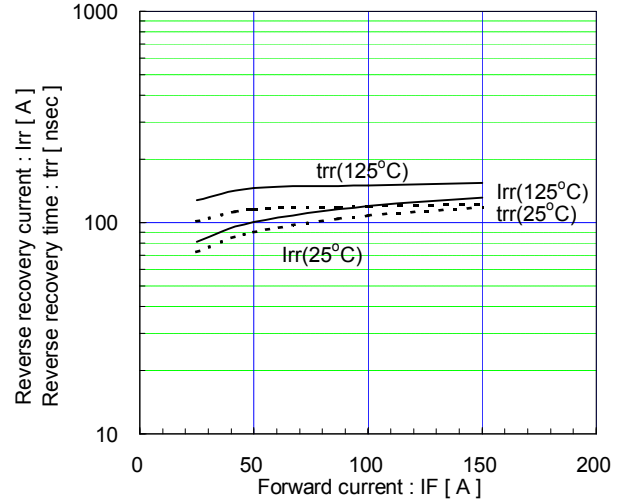

Transient thermal resistance (max.)

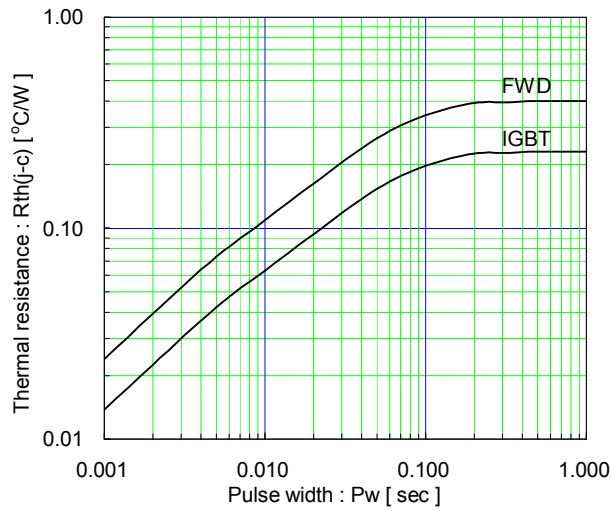

Warnings

- This product shall be used within its absolute maximum rating (voltage, current, and temperature). This product may be broken in case of using beyond the ratings.
製品の絶対最大定格(電圧, 電流, 温度等)の範囲内で御使用下さい。絶対最大定格を超えて使用すると、素子が破壊する場合があります。
- Connect adequate fuse or protector of circuit between three-phase line and this product to prevent the equipment from causing secondary destruction, such as fire, its spreading, or explosion.
万一の不慮の事故で素子が破壊した場合を考慮し、商用電源と本製品の間に適切な容量のヒューズ又はブレーカーを必ず付けて火災, 爆発, 延焼等の2次破壊を防いでください。
- Use this product after realizing enough working on environment and considering of product's reliability life.
This product may be broken before target life of the system in case of using beyond the product's reliability life.
製品の使用環境を十分に把握し、製品の信頼性寿命が満足できるか検討の上、本製品を適用して下さい。製品の信頼性寿命を超えて使用した場合、装置の目標寿命より前に素子が破壊する場合があります。
- If the product had been used in the environment with acid, organic matter, and corrosive gas (hydrogen sulfide, sulfurous acid gas), the product's performance and appearance can not be ensured easily.
酸・有機物・腐食性ガス(硫化水素, 亜硫酸ガス等)を含む環境下で使用された場合、製品機能・外観等の保証はできません。
- Use this product within the power cycle curve (Technical Rep.No. : MT5F12959). Power cycle capability is classified to delta-Tj mode which is stated as above and delta-Tc mode. Delta-Tc mode is due to rise and down of case temperature (Tc), and depends on cooling design of equipment which use this product. In application which has such frequent rise and down of Tc, well consideration of product life time is necessary.
本製品は、パワーサイクル寿命カーブ以下で使用下さい(技術資料No.: MT5F12959)。パワーサイクル耐量にはこの ΔT_j による場合の他に、 ΔT_c による場合があります。これはケース温度(T_c)の上昇下降による熱ストレスであり、本製品をご使用の際の放熱設計に依存します。ケース温度の上昇下降が頻繁に起こる場合は、製品寿命に十分留意してご使用下さい。
- Never add mechanical stress to deform the main or control terminal. The deformed terminal may cause poor contact problem.
主端子及び制御端子に応力を与えて変形させないで下さい。端子の変形により、接触不良などを引き起こす場合があります。
- Use this product with keeping the cooling fin's flatness between screw holes within 100um at 100mm and the roughness within 10um. Also keep the tightening torque within the limits of this specification. Too large convex of cooling fin may cause isolation breakdown and this may lead to a critical accident. On the other hand, too large concave of cooling fin makes gap between this product and the fin bigger, then, thermal conductivity will be worse and over heat destruction may occur.
冷却フィンにはネジ取り付け位置間で平坦度を100mmで100um以下、表面の粗さは10um以下にして下さい。過大な凸反りがあったりすると本製品が絶縁破壊を起こし、重大事故に発展する場合があります。また、過大な凹反りやゆがみ等があると、本製品と冷却フィンの間空隙が生じて放熱が悪くなり、熱破壊に繋がる場合があります。
- In case of mounting this product on cooling fin, use thermal compound to secure thermal conductivity. If the thermal compound amount was not enough or its applying method was not suitable, its spreading will not be enough, then, thermal conductivity will be worse and thermal run away destruction may occur.
Confirm spreading state of the thermal compound when its applying to this product.
(Spreading state of the thermal compound can be confirmed by removing this product after mounting.)
素子を冷却フィンに取り付ける際には、熱伝導を確保するためのコンパウンド等をご使用ください。又、塗布量が不足したり、塗布方法が不適だったりすると、コンパウンドが十分に素子全体に広がらず、放熱悪化による熱破壊に繋がる事があります。コンパウンドを塗布する際には、製品全面にコンパウンドが広がっている事を確認してください。
(実装した後に素子を取りはずすとコンパウンドの広がり具合を確認する事が出来ます。)
- It shall be confirmed that IGBT's operating locus of the turn-off voltage and current are within the RBSOA specification. This product may be broken if the locus is out of the RBSOA.
ターンオフ電圧・電流の動作軌跡がRBSOA仕様内にあることを確認して下さい。RBSOAの範囲を超えて使用すると素子が破壊する可能性があります。
- If excessive static electricity is applied to the control terminals, the devices may be broken. Implement some countermeasures against static electricity.
制御端子に過大な静電気が印加された場合、素子が破壊する場合があります。取り扱い時は静電気対策を実施して下さい。

This material and the information herein is the property of Fuji Electric Device Technology Co.,Ltd. They shall be neither reproduced, copied, lent, or disclosed in any way whatsoever for the use of any third party nor used for the manufacturing purposes without the express written consent of Fuji Electric Device Technology Co.,Ltd.

This material and the information herein is the property of Fuji Electric Device Technology Co., Ltd. They shall be neither reproduced, copied, lent, or disclosed in any way whatsoever for the use of any third party nor used for the manufacturing purposes without the express written consent of Fuji Electric Device Technology Co., Ltd.

Warnings

- Never add the excessive mechanical stress to the main or control terminals when the product is applied to equipments. The module structure may be broken.
素子を装置に実装する際に、主端子や制御端子に過大な応力を与えないで下さい。端子構造が破壊する可能性があります。
- In case of insufficient -VGE, erroneous turn-on of IGBT may occur. -VGE shall be set enough value to prevent this malfunction. (Recommended value : -VGE = -15V)
逆バイアスゲート電圧-VGEが不足しますと誤点弧を起こす可能性があります。誤点弧を起こさない為に-VGEは十分な値で設定して下さい。(推奨値 : -VGE = -15V)
- In case of higher turn-on dv/dt of IGBT, erroneous turn-on of opposite arm IGBT may occur. Use this product in the most suitable drive conditions, such as +VGE, -VGE, RG to prevent the malfunction.
ターンオン dv/dt が高いと対抗アームのIGBTが誤点弧を起こす可能性があります。誤点弧を起こさない為の最適なドライブ条件(+VGE, -VGE, RG等)でご使用下さい。
- This product may be broken by avalanche in case of VCE beyond maximum rating VCES is applied between C-E terminals. Use this product within its absolute maximum voltage.
VCESを超えた電圧が印加された場合、アバランシェを起こして素子破壊する場合があります。VCEは必ず絶対定格の範囲内でご使用下さい。

Cautions

- Fuji Electric Device Technology is constantly making every endeavor to improve the product quality and reliability. However, semiconductor products may rarely happen to fail or malfunction. To prevent accidents causing injury or death, damage to property like by fire, and other social damage resulted from a failure or malfunction of the Fuji Electric Device Technology semiconductor products, take some measures to keep safety such as redundant design, spread-fire-preventive design, and malfunction-protective design.
富士電機デバイステクノロジーは絶えず製品の品質と信頼性の向上に努めています。しかし、半導体製品は故障が発生したり、誤動作する場合があります。富士電機デバイステクノロジー製半導体製品の故障または誤動作が、結果として人身事故・火災等による財産に対する損害や社会的な損害を起こさないように冗長設計・延焼防止設計・誤動作防止設計など安全確保のための手段を講じて下さい。
- The application examples described in this specification only explain typical ones that used the Fuji Electric Device Technology products. This specification never ensure to enforce the industrial property and other rights, nor license the enforcement rights.
本仕様書に記載してある応用例は、富士電機デバイステクノロジー製品を使用した代表的な応用例を説明するものであり、本仕様書によって工業所有権、その他権利の実施に対する保障または実施権の許諾を行うものではありません。
- The product described in this specification is not designed nor made for being applied to the equipment or systems used under life-threatening situations. When you consider applying the product of this specification to particular used, such as vehicle-mounted units, shipboard equipment, aerospace equipment, medical devices, atomic control systems and submarine relaying equipment or systems, please apply after confirmation of this product to be satisfied about system construction and required reliability.
本仕様書に記載された製品は、人命にかかわるような状況下で使用される機器あるいはシステムに用いられることを目的として設計・製造されたものではありません。本仕様書の製品を車両機器、船舶、航空宇宙、医療機器、原子力制御、海底中継機器あるいはシステムなど、特殊用途へのご利用をご検討の際は、システム構成及び要求品質に満足することをご確認の上、ご利用下さい。

If there is any unclear matter in this specification, please contact Fuji Electric Device Technology Co., Ltd.